

Accuphase

STEREO POWER AMPLIFIER

P-4600

- 6-parallel push-pull power transistor output stage
- Large output 150 W / 8 ohms, 300 W / 4 ohms, 450 W / 2 ohms
- Instrumentation amplifier principle
- Current feedback amplification circuits
- Balanced remote sensing
- MCS+ circuit
- High damping factor of 800
- Speaker output protection
- Highly responsive large-scale power meters
- Support for bi-amping and bridged mode connections





A stereo power amplifier that envelops you in pure music listening

Filled with the highest-quality technologies, the P-4600 Class AB stereo power amplifier provides supreme driving performance. The power amp stage features 6-parallel push-pull power transistors, while its rated output of 150 W into 8 ohms dwarfs conventional models. Combined with an S/N ratio of 125 dB and a damping factor of 800, it drives large speakers with ease and creates a rich, deep soundscape. The P-4600 power amplifier extracts the complete breadth of recordings, vividly recreating the rush of live performances, and lets you enjoy the very essence of musical performances.

Groundbreaking technology

The P-4600 power amplifier was created by carefully implementing a series of state-of-the-art circuitry and the highest quality materials.

Ample output power

The 6-parallel push-pull power transistor output stage produces linear output power of 150 W into 8 ohms, 300 W into 4 ohms, and a massive 450 W into 2 ohms of maximum output power.

High noise suppression performance

Ideal gain distribution and other sophisticated techniques improve noise level suppression by 18% over conventional models.

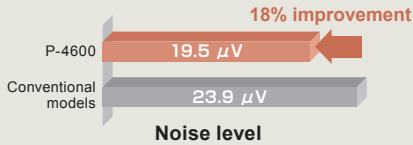

High damping factor

With a damping factor of 800, the speakers can be driven with full control over the counterelectromotive forces to get the most out of your speakers.

Ideal gain distribution

By achieving a high gain (12.6x) in the signal input section combined with the already superb noise performance creates a dramatic reduction in output noise.

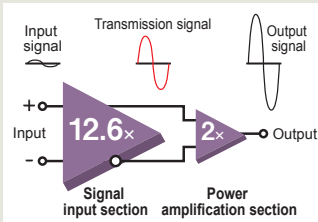

Balanced remote sensing

Balanced remote sensing improves the damping factor by feeding back the GND at the same time as the signal output from the speaker terminals.

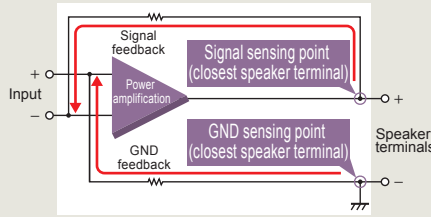

Instrumentation amplifier

With balanced circuits in the signal input section, the amplification stage is comprised entirely of an instrumentation amplifier principle that equalizes impedance on the + and - sides, for excellent external noise suppression, and provides optimal circuitry for a high-end audio amplifier.

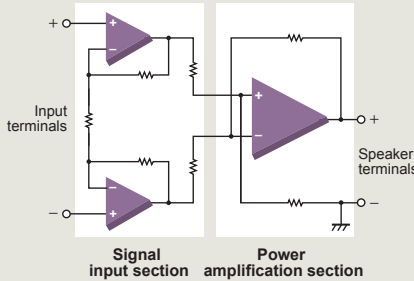

MCS+ circuitry

By placing the voltage amplification stage in a two-parallel circuit layout, the MCS+ (Multiple Circuit Summing-up) circuit theoretically lowers the noise floor by about 30%.

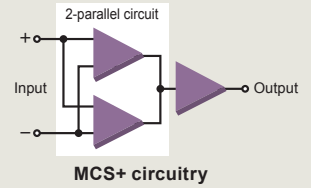

2-parallel circuit layout of MCS+ principle

Current feedback amplification topology

The current feedback amplification circuit offers exceptional performance in the high ranges with almost no impact on the frequency characteristics even when gain is switched, resulting in natural and dynamic driving of the speakers.

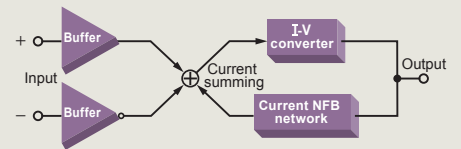

Three-stage Darlington configuration

The three-stage Darlington configuration that drives the final output stage by a two-stage drive circuit minimizes any negative influence on the output stage from the counter-electromotive forces of the speakers.

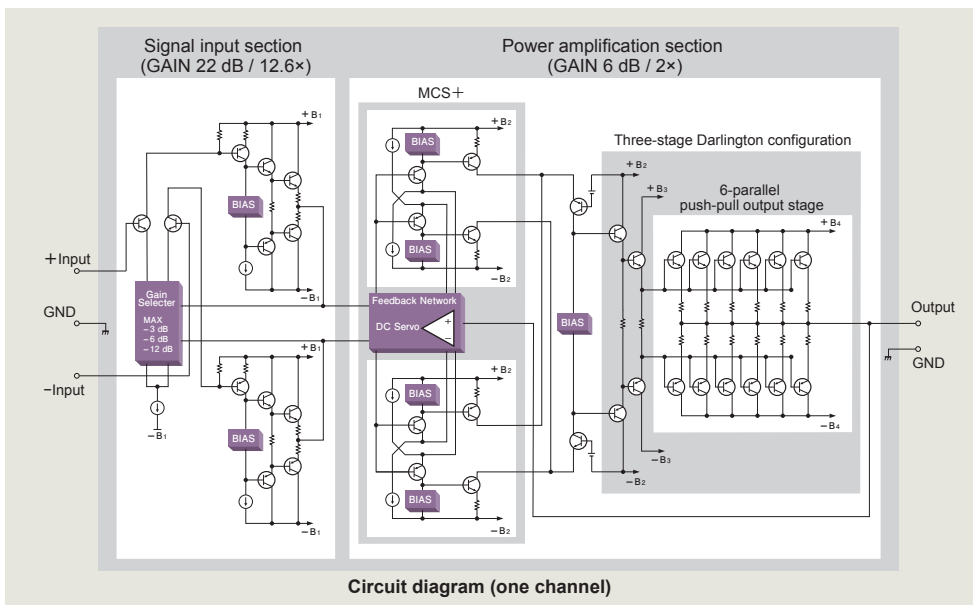

Advanced features

- Large output 150 W / 8 ohms, 300 W / 4 ohms, 450 W / 2 ohms
- 6-parallel push-pull power transistor output stage
- Instrumentation amplifier principle
- Current feedback amplification circuits
- Balanced remote sensing
- MCS+ circuit
- Three-stage Darlington configuration
- High damping factor of 800
- Meter display selector ①
- LINE / BALANCED input switching ②
- 4-step gain control ③
- Polarity switching of balanced input connectors ④
- Support for bi-amping and bridged modes ⑤
- Ideal gain distribution in the signal input section ⑥
- Speaker output protection circuit guards against short-circuiting ⑦
- Large speaker terminals connected directly to protection circuitry ⑧
- Highly reliable MOS-FET switches with no mechanical connections ⑨
- Large, high-efficiency toroidal transformer ⑩
- High-capacity 50,000 μ F filtering capacitors ⑪
- Aluminum hairline finish top plate ⑫
- High-carbon cast iron insulator feet with superior damping characteristics ⑬
- Large, high-sensitivity power meters ranging from -50 dB ⑭
- Power amplification section with a large heat sink ⑮

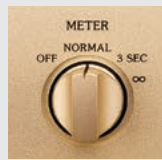

① Meter display selector



② Input selector button ③ Gain selector

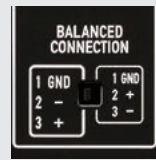

④ Balanced input polarity selector



⑤ Operation selector

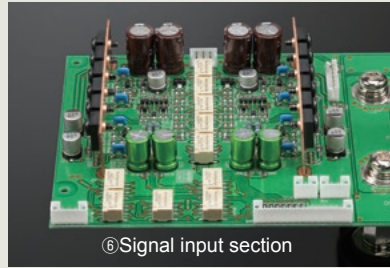

⑥ Signal input section

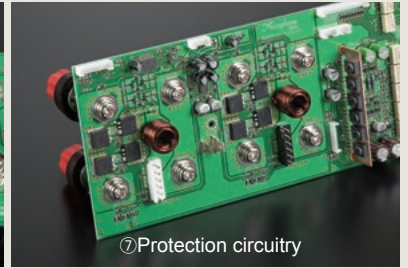

⑦ Protection circuitry



⑧ Speaker terminals



⑨ MOS-FET switches



⑩ Toroidal transformer



⑪ Filtering capacitors



⑫ Top plate



⑬ Insulator feet

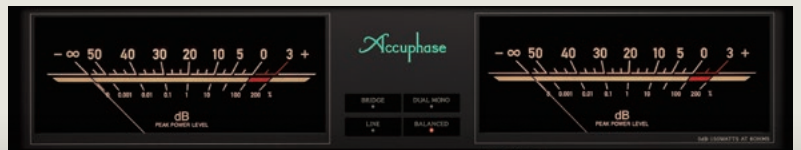

⑭ Power meters



⑮ Power amplification section



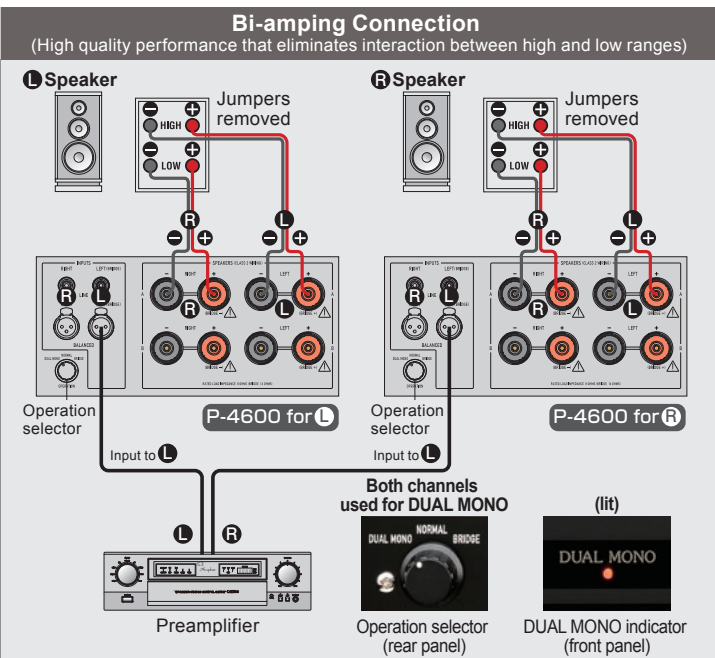
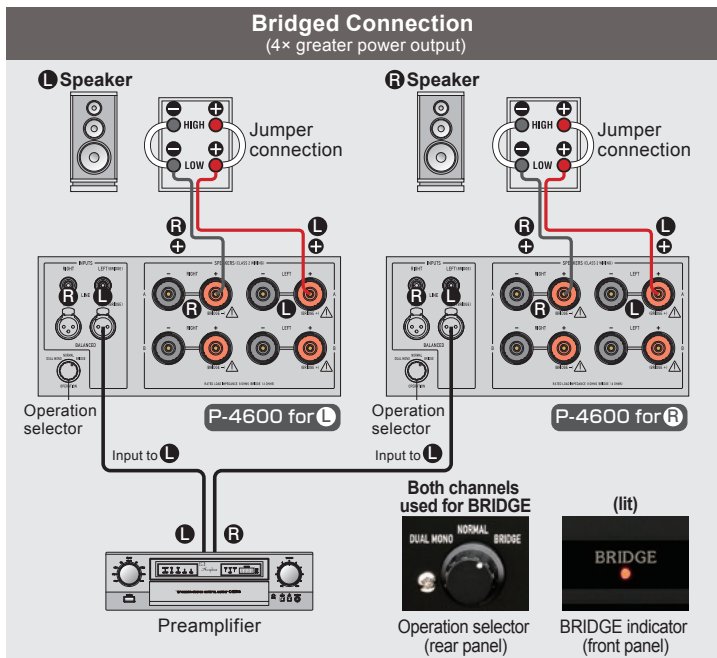

Front Panel

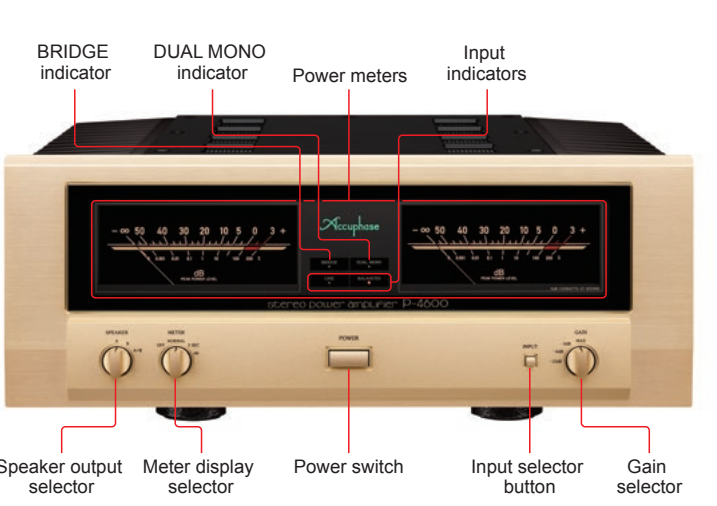

Rear Panel

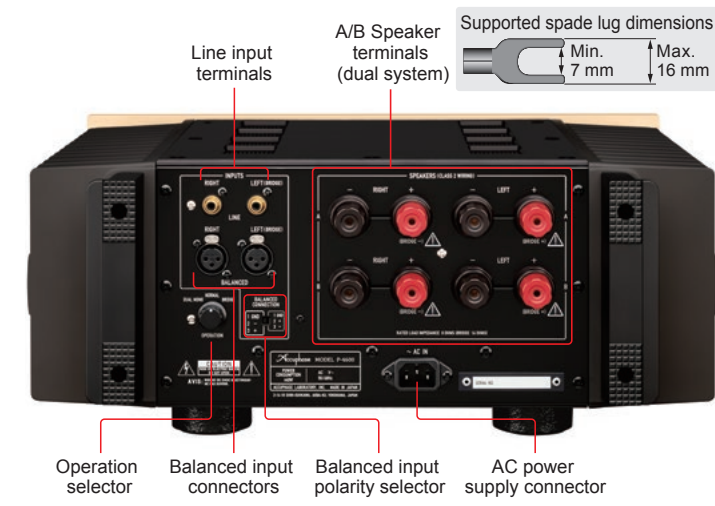

P-4600 Guaranteed Specifications

| | | | | |
|------------------------------------------------------|--------------------------------|--------------------------------|---------------|---------|
| Rated Output (20 – 20,000 Hz, 0.05%) | Load | 8 ohms | 4 ohms | 2 ohms |
| | Normal / Bi-amping connection | 150 W | 300 W*1 | 450 W*1 |
| Total Harmonic Distortion (20 – 20,000 Hz) | Normal / Bi-amping connection | 2 ohms | 0.05% | |
| | Bridged connection | 4 to 16 ohms | 0.03% | |
| Intermodulation Distortion | Bridged connection | 4 to 16 ohms | 0.05% | |
| Frequency Response | At rated output | 20 – 20,000 Hz (+0, –0.2 dB) | | |
| | At 1 W output | 0.5 – 160,000 Hz (+0, –3.0 dB) | | |
| Damping Factor | Normal / Bi-amping connection | 800 or greater | | |
| Input Impedance | BALANCED / LINE input | 40 kilohms / 20 kilohms | | |
| | Output | At rated output | At 1 W output | |
| Input Sensitivity | Normal / Bi-amping connection | 1.38 V | 0.11 V | |
| | Bridged connection | 2.76 V | 0.11 V | |
| Signal-to-Noise Ratio (A-weighted, input shorted) | Gain switch at MAX / at –12 dB | 125 dB/130 dB | | |

| | | | | | |
|--------------------|--------------------------------------------------------------------|-------------------------------------------------|-------|-------|--------|
| Gain | Gain switch | MAX | –3 dB | –6 dB | –12 dB |
| | Normal / Bi-amping / Bridged connection | 28 dB | 25 dB | 22 dB | 16 dB |
| Power Meters | Format | Logarithmic scale, with illumination off switch | | | |
| | Display range | –∞ to +3 dB | | | |
| | Peak hold time | 0 sec. / 3 sec. / ∞ switchable | | | |
| Power Requirements | 120/220/230 V AC, 50/60 Hz (Voltage as indicated on rear panel) | | | | |
| Power Consumption | Idle | 94 W | | | |
| | In accordance with IEC 62368-1 | 250 W | | | |
| | Stand-by | 0.3 W | | | |
| Maximum Dimensions | Width 465 mm (18.3") × Height 190 mm (7.5") × Depth 427 mm (16.8") | | | | |
| Mass | Net | 30.0 kg (66.2 lbs) | | | |
| | In shipping carton | 36 kg (80 lbs) | | | |

● "Normal connection" indicates standard stereo operation.
*1: Limited to music signals

Supplied accessories
● AC power cord

Remarks
★ This product is available in versions for 120/220/230 V AC. Make sure that the voltage shown on the rear panel matches the AC line voltage in your area.
★ The 230 V version has an Eco Mode that switches power off after 120 minutes of inactivity.
★ The shape of the plug of the supplied AC power cord depends on the voltage rating and destination country.



● The specifications and appearance of this product are subject to change without notice.
<https://www.accuphase.com>

ACCUPHASE LABORATORY, INC.
J2305Y 850-2239-00 (B1) PRINTED IN JAPAN